

Übungs - Dossier

Plusrechnen

im Tausenderraum

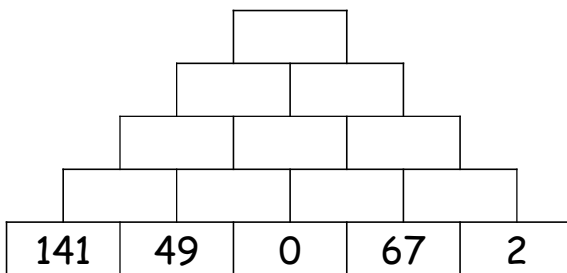

$$362 + 471 = \underline{\quad}$$

$$361 + 471 = \underline{\quad}$$

$$363 + 471 = \underline{\quad}$$

$$362 + 470 = \underline{\quad}$$

$$362 + 472 = \underline{\quad}$$

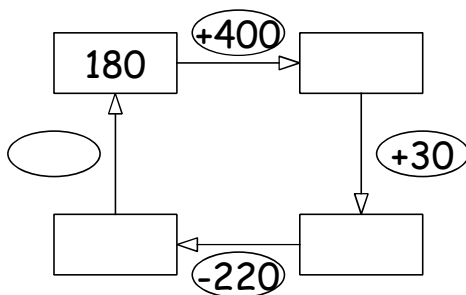

3+5=?



Name:

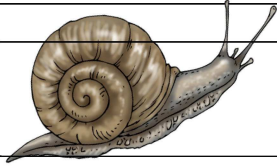

Einfache Plusaufgaben 1

$307 + 30 = \underline{\hspace{2cm}}$

$319 + 60 = \underline{\hspace{2cm}}$

$306 + 30 = \underline{\hspace{2cm}}$

$318 + 60 = \underline{\hspace{2cm}}$

$308 + 30 = \underline{\hspace{2cm}}$

$320 + 60 = \underline{\hspace{2cm}}$

$307 + 29 = \underline{\hspace{2cm}}$

$319 + 59 = \underline{\hspace{2cm}}$

$307 + 31 = \underline{\hspace{2cm}}$

$319 + 61 = \underline{\hspace{2cm}}$

$542 + 40 = \underline{\hspace{2cm}}$

$637 + 60 = \underline{\hspace{2cm}}$

$541 + 40 = \underline{\hspace{2cm}}$

$636 + 60 = \underline{\hspace{2cm}}$

$543 + 40 = \underline{\hspace{2cm}}$

$638 + 60 = \underline{\hspace{2cm}}$

$542 + 39 = \underline{\hspace{2cm}}$

$637 + 59 = \underline{\hspace{2cm}}$

$542 + 41 = \underline{\hspace{2cm}}$

$637 + 61 = \underline{\hspace{2cm}}$

$939 + 60 = \underline{\hspace{2cm}}$

$739 + 30 = \underline{\hspace{2cm}}$

$938 + 60 = \underline{\hspace{2cm}}$

$738 + 30 = \underline{\hspace{2cm}}$

$940 + 60 = \underline{\hspace{2cm}}$

$740 + 30 = \underline{\hspace{2cm}}$

$939 + 59 = \underline{\hspace{2cm}}$

$739 + 29 = \underline{\hspace{2cm}}$

$939 + 61 = \underline{\hspace{2cm}}$

$739 + 31 = \underline{\hspace{2cm}}$

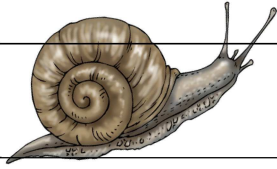

Einfache Plusaufgaben 2

$338 + 40 = \underline{\quad}$

$638 + 30 = \underline{\quad}$

$337 + 40 = \underline{\quad}$

$637 + 30 = \underline{\quad}$

$339 + 40 = \underline{\quad}$

$639 + 30 = \underline{\quad}$

$338 + 39 = \underline{\quad}$

$638 + 29 = \underline{\quad}$

$338 + 41 = \underline{\quad}$

$638 + 31 = \underline{\quad}$

$557 + 30 = \underline{\quad}$

$904 + 60 = \underline{\quad}$

$556 + 30 = \underline{\quad}$

$903 + 60 = \underline{\quad}$

$558 + 30 = \underline{\quad}$

$905 + 60 = \underline{\quad}$

$557 + 29 = \underline{\quad}$

$904 + 59 = \underline{\quad}$

$557 + 31 = \underline{\quad}$

$904 + 61 = \underline{\quad}$

$709 + 80 = \underline{\quad}$

$26 + 70 = \underline{\quad}$

$708 + 80 = \underline{\quad}$

$25 + 70 = \underline{\quad}$

$710 + 80 = \underline{\quad}$

$27 + 70 = \underline{\quad}$

$709 + 79 = \underline{\quad}$

$26 + 69 = \underline{\quad}$

$709 + 81 = \underline{\quad}$

$26 + 71 = \underline{\quad}$

Überlege gut und rechne geschickt 1

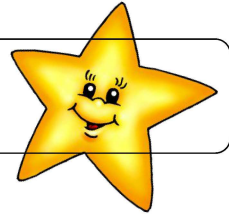

$113 + 420 = \underline{\quad}$

$176 + 705 = \underline{\quad}$

$112 + 420 = \underline{\quad}$

$175 + 705 = \underline{\quad}$

$114 + 420 = \underline{\quad}$

$177 + 705 = \underline{\quad}$

$113 + 419 = \underline{\quad}$

$176 + 704 = \underline{\quad}$

$113 + 421 = \underline{\quad}$

$176 + 706 = \underline{\quad}$

$167 + 765 = \underline{\quad}$

$401 + 152 = \underline{\quad}$

$166 + 765 = \underline{\quad}$

$400 + 152 = \underline{\quad}$

$168 + 765 = \underline{\quad}$

$402 + 152 = \underline{\quad}$

$167 + 764 = \underline{\quad}$

$401 + 151 = \underline{\quad}$

$167 + 766 = \underline{\quad}$

$401 + 153 = \underline{\quad}$

$795 + 118 = \underline{\quad}$

$618 + 242 = \underline{\quad}$

$794 + 118 = \underline{\quad}$

$617 + 242 = \underline{\quad}$

$796 + 118 = \underline{\quad}$

$619 + 242 = \underline{\quad}$

$795 + 117 = \underline{\quad}$

$618 + 241 = \underline{\quad}$

$795 + 119 = \underline{\quad}$

$618 + 243 = \underline{\quad}$

Überlege gut und rechne geschickt 2

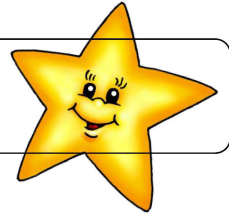

$795 + 118 = \underline{\quad}$

$367 + 180 = \underline{\quad}$

$794 + 118 = \underline{\quad}$

$366 + 180 = \underline{\quad}$

$796 + 118 = \underline{\quad}$

$368 + 180 = \underline{\quad}$

$795 + 117 = \underline{\quad}$

$367 + 179 = \underline{\quad}$

$795 + 119 = \underline{\quad}$

$367 + 181 = \underline{\quad}$

$547 + 142 = \underline{\quad}$

$29 + 846 = \underline{\quad}$

$546 + 142 = \underline{\quad}$

$28 + 846 = \underline{\quad}$

$548 + 142 = \underline{\quad}$

$30 + 846 = \underline{\quad}$

$547 + 141 = \underline{\quad}$

$29 + 845 = \underline{\quad}$

$547 + 143 = \underline{\quad}$

$29 + 847 = \underline{\quad}$

$199 + 143 = \underline{\quad}$

$176 + 528 = \underline{\quad}$

$198 + 143 = \underline{\quad}$

$175 + 528 = \underline{\quad}$

$200 + 143 = \underline{\quad}$

$177 + 528 = \underline{\quad}$

$199 + 142 = \underline{\quad}$

$176 + 527 = \underline{\quad}$

$199 + 144 = \underline{\quad}$

$176 + 529 = \underline{\quad}$

Immer plus ???

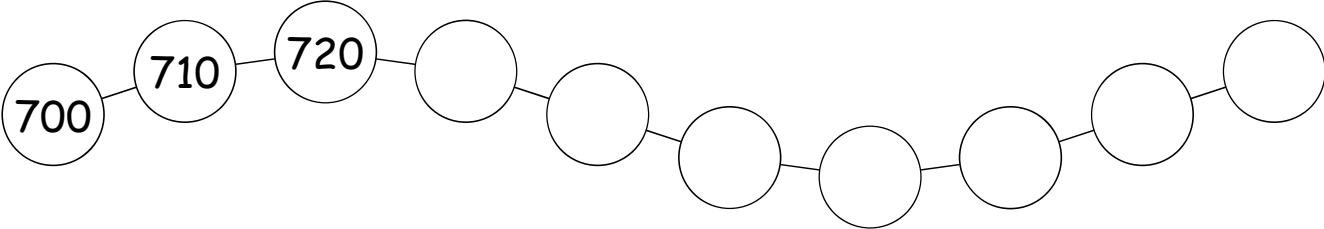

Immer plus ___

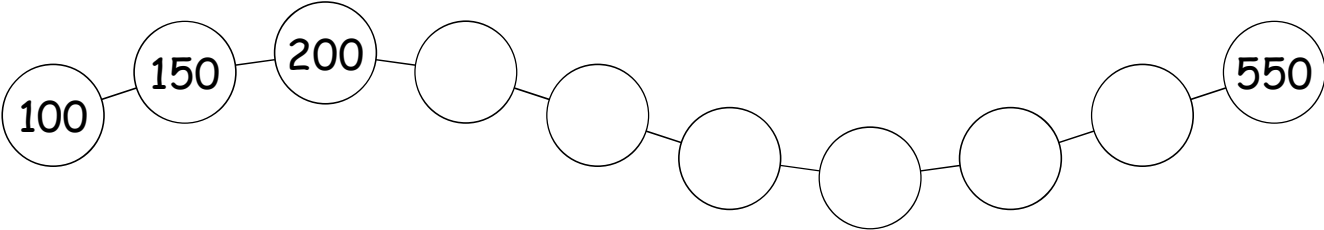

Immer plus ___

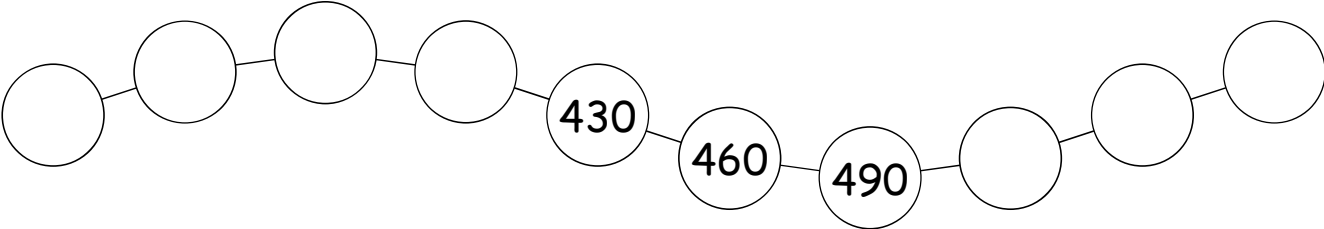

Immer plus ___

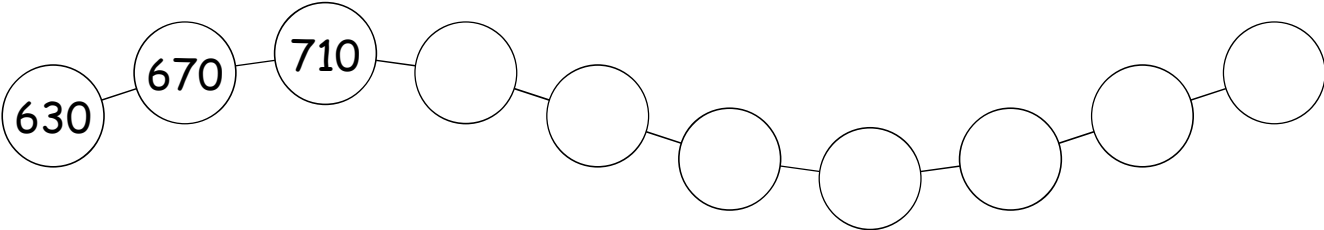

Immer plus ___

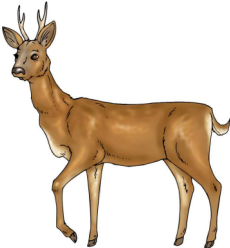

Zahlenmauern

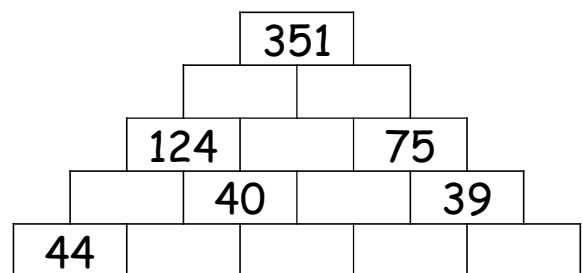
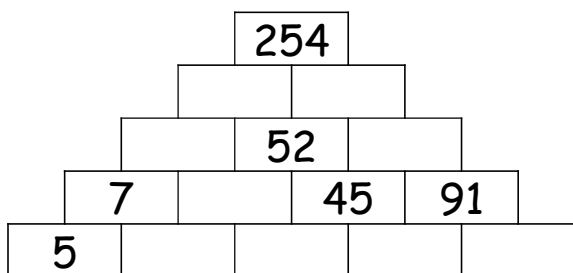
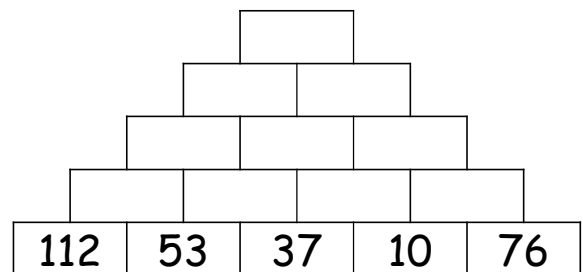
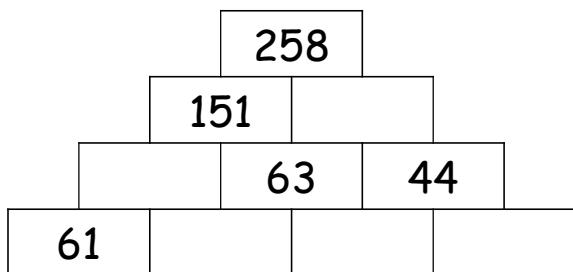
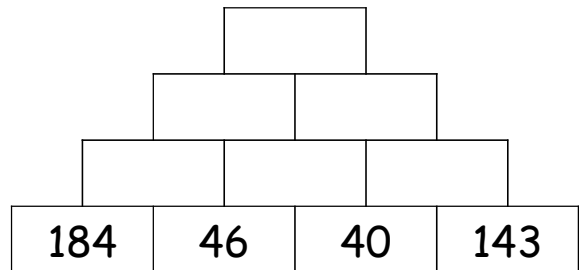
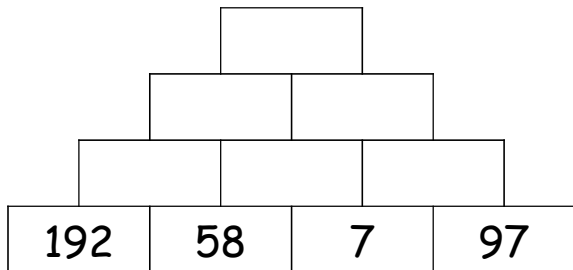

Hier noch zwei Knobelmauern. Findest du die Zahlen?

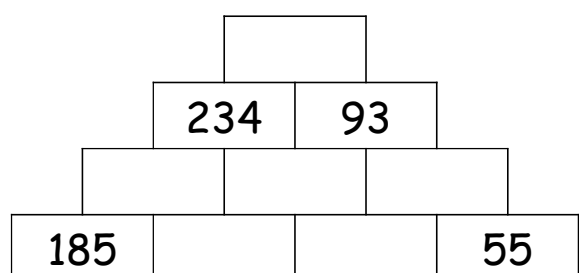
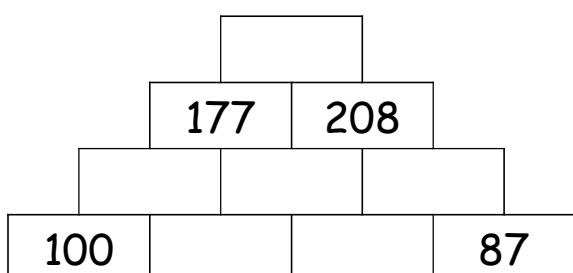

Gemischte Aufgaben 1

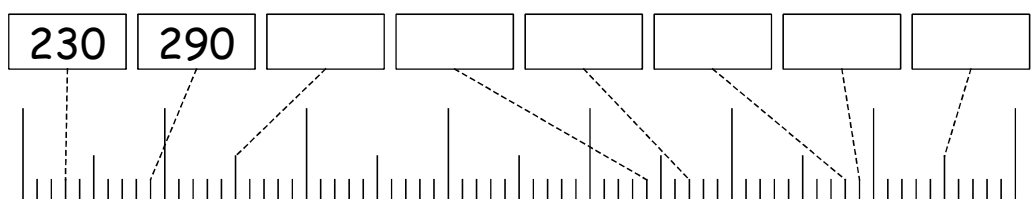
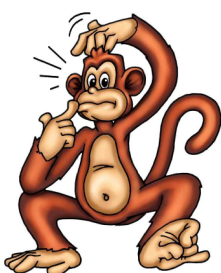
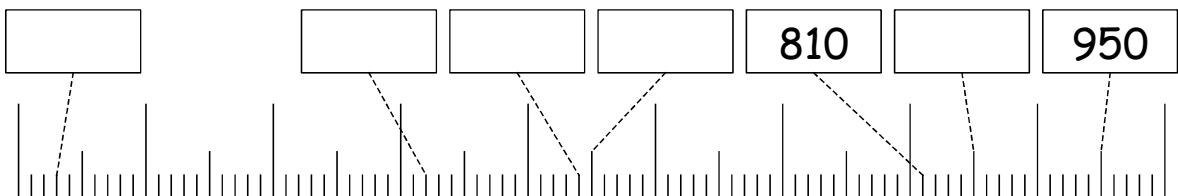
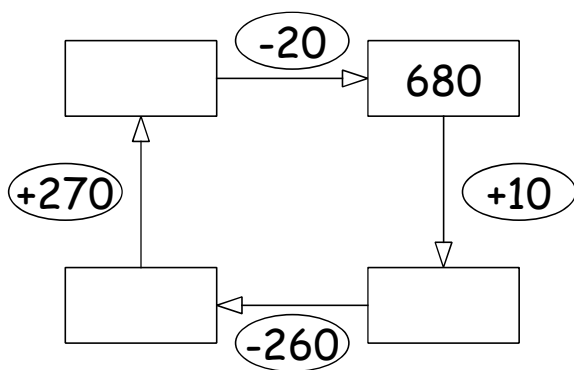
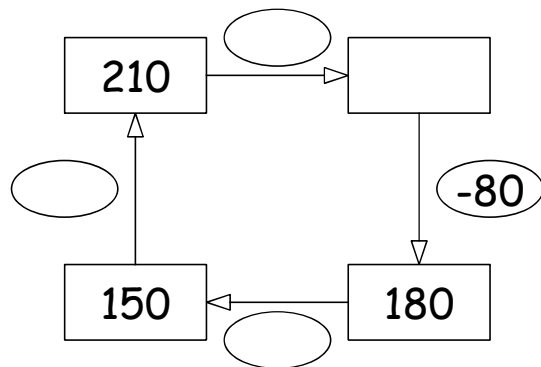
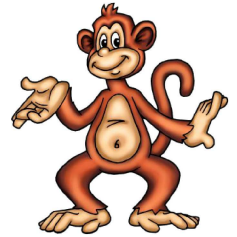
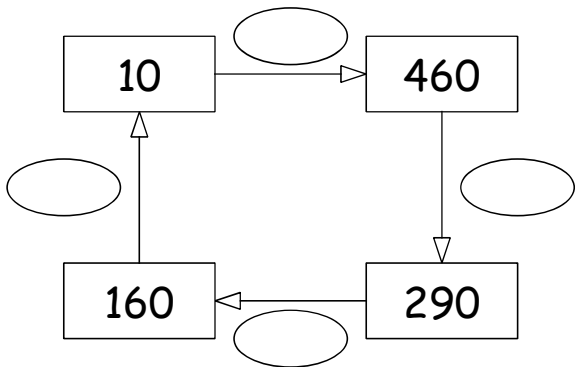

Gemischte Aufgaben 2

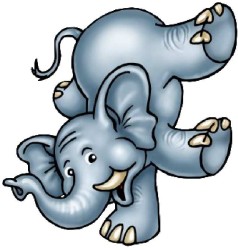

790	
290	
20	
460	
90	

850	
580	
340	
30	
430	

640	
90	
140	
590	
320	

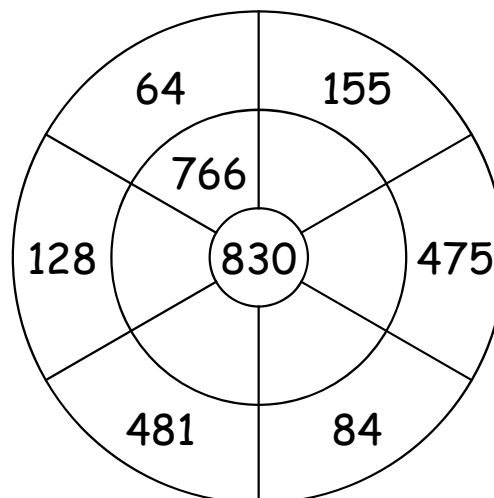
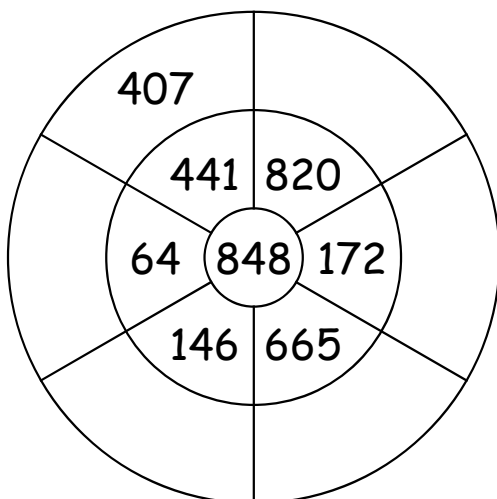
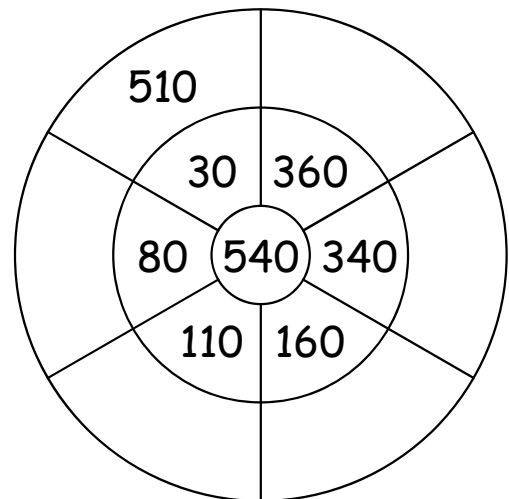

Gemischte Aufgaben 3

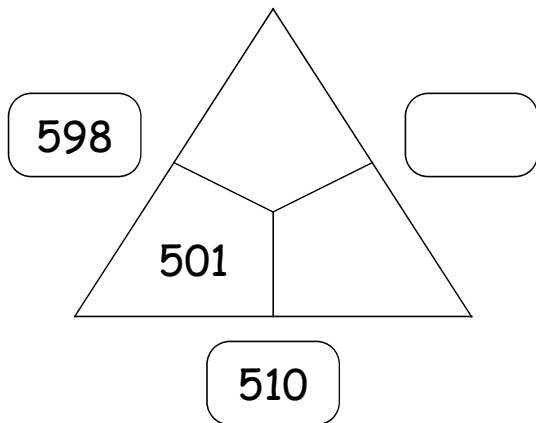
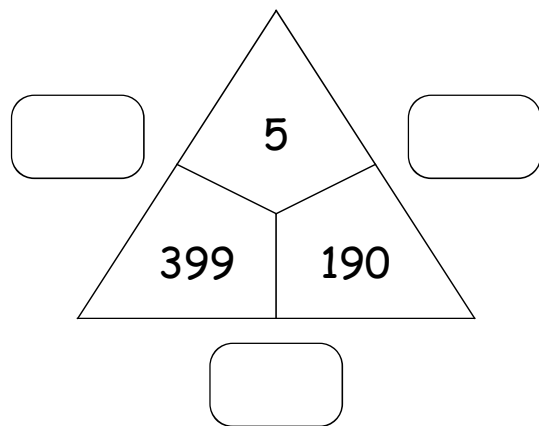
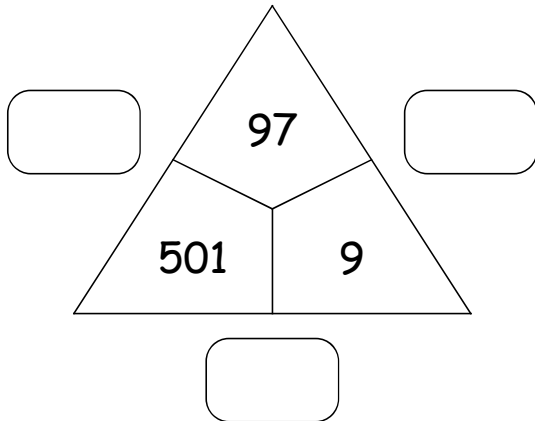

Welche Zahl plus 474 ist 903?

Rechnung:

				+	4	7	4	=	9	0	3	



Antwort: Die Zahl _____ plus 474 ist 903.

Du hast es geschafft

